

Panasonic®

Advanced Hybrid System

User Guide

for Single Line Telephone





Model No. **KX-TA824**



















Please read this guide before using and save for future reference.

















Document Version: 2006-05

Features List



















 Feature number
  Off-hook
  On-hook
  Talk

Desired Feature	Operation
Making Calls	
Calling	To an extension  ► <input data-bbox="393 336 521 379" type="text" value="extension no."/> ► 
	To an external party  ► <input data-bbox="404 448 505 491" type="text" value="phone no."/> ► 
Redial	 ► <input data-bbox="387 520 428 563" type="text" value="8"/> <input data-bbox="449 520 490 563" type="text" value="0"/> / <input data-bbox="533 520 574 563" type="text" value="#"/> <input data-bbox="589 520 630 563" type="text" value="#"/> ► 
Calling an operator	 ► <input data-bbox="387 584 428 627" type="text" value="0"/> ► 
Speed Dialing (Personal)	To store  ► <input data-bbox="398 687 440 730" type="text" value="2"/> <input data-bbox="454 687 496 730" type="text" value="*"/> ► <input data-bbox="538 687 745 730" type="text" value="personal speed dial no."/> ► <input data-bbox="801 687 897 730" type="text" value="desired no."/> ► <small>(0-9)</small> ► <input data-bbox="331 751 372 794" type="text" value="#"/> ► 
	To dial  ► <input data-bbox="398 863 440 906" type="text" value="1"/> <input data-bbox="454 863 496 906" type="text" value="*"/> / <input data-bbox="533 863 574 906" type="text" value="#"/> ► <input data-bbox="622 863 829 906" type="text" value="personal speed dial no."/> ►  <small>(0-9)</small>
Speed Dialing (System)	To dial  ► <input data-bbox="398 967 440 1010" type="text" value="*"/> ► <input data-bbox="505 967 701 1010" type="text" value="system speed dial no."/> ►  <small>(00-99)</small>
Receiving Calls	
Picking up a call	 ► <div style="border: 1px dashed black; padding: 10px; display: inline-block;"> <p>Directed</p> <input data-bbox="398 1142 440 1185" type="text" value="4"/> ► <input data-bbox="510 1142 633 1185" type="text" value="extension no."/> </div> ►  <p>Group</p> <input data-bbox="398 1222 440 1265" type="text" value="4"/> <input data-bbox="454 1222 496 1265" type="text" value="0"/>











Features List

Desired Feature	Operation	
When the Dialed Extension is Busy/No Answer		
Automatic Callback Busy	To set <i>While hearing a busy tone</i>  ► 6 ► 	To call <i>If you hear callback ringing</i> 
Message Waiting	Sender	To leave a notification  ► 7 0 ► 1 ► receiver's extension no. ► ► # / 0 ►  <hr/> To cancel a notification  ► 7 0 ► 2 ► receiver's extension no. ► ► # / 0 ► 
	Receiver	To call back  ► 7 8 4 ► # ►  <hr/> To clear all notifications  ► 7 0 0 ► # ► 
Call Waiting	Sender	<i>While hearing a busy tone</i> 1 ► Wait for an answer. ► 
	Receiver	 ► <div style="border: 1px dashed black; padding: 10px; display: inline-block;"> <p>For outside calls</p> <p>7 3 1 1 # Set</p> <p>7 3 1 0 # Cancel</p> <p>For intercom calls/doorphone calls</p> <p>7 3 2 1 # Set</p> <p>7 3 2 0 # Cancel</p> </div> ► 
		To talk to the new party <i>While hearing the Call Waiting tone</i> Terminating a current status  ►  ► 



Features List

Desired Feature	Operation
During a Conversation	
Holding a call	<p>Holding</p>  ►  To retrieve a call at the holding extension 
	<p>To retrieve an outside call from another extension</p>  ► 5 3 ► held line no. ► 
Transferring a call	 ► extension no. To an extension ► Wait for an answer. ►  ► Announce. ► 
Useful Features	
Paging	<p>To page</p>  ► <div style="border: 1px dashed black; padding: 10px; margin: 10px 0;"> <p>All extensions</p> <p>3 3 0</p> <p>Group</p> <p>3 3 ► group no.</p> <p>All external speakers</p> <p>3 4</p> <p>All extensions & external speakers</p> <p>3 3 *</p> </div> ►  Announce. <p>To answer an announced page</p>  ► 4 3 ► 
Three-party conference	 ► third party's no. ►  ►  3
Setting Absent Message	<p>To set</p>  ► 7 5 ► message no. ► parameter (if required) ► # ► 
	<p>To cancel</p>  ► 7 5 0 # ► 

Features List

Desired Feature	Operation
Useful Features	
Log-In/Log-Out	 ► [7 3 6 0 #] For Log-In [7 3 6 1 #] For Log-Out ► 
Forwarding a call	 ► [7 1] ►  <div style="border: 1px dashed black; padding: 10px; margin: 10px auto; width: 80%;"> <p>All calls [1] ► extension no. ► [#]</p> <p>Busy/No answer [2] ► extension no. ► [#]</p> <p>To an outside line [3] ► line access code ► phone no. ► [#]</p> <p>Follow Me [5] ► your extension no. ► [#]</p> <p>Cancel Follow Me [8] ► your extension no. ► [#]</p> <p>Cancel [0] ► [#]</p> <p>To Voice Mail</p> <p>All calls [1] ► VPS extension no. ► [#]</p> <p>Busy/No answer [2] ► VPS extension no. ► [#]</p> <p>Cancel [0] ► [#]</p> </div>
Do Not Disturb (DND)	 ► [7 1] ► [4 #] Set [0 #] Cancel ► 
Locking your extension	(Lock code is 4 digits.)  ► [7 7 lock code lock code ► [#] Lock [7 7 lock code ► [#] Unlock] ► 
Clearing the setting	 ► [7 9 #] ► 

Features List

Desired Feature	Operation	
Making Use of the Voice Mail Service		
Listening to a message	From your own extension	 ▶ VPS extension no. ▶ ▶ VPS password # <ul style="list-style-type: none"> • If you have no password, you can skip the last step.
	From someone else's extension	 ▶ VPS extension no. ▶ ▶ # 6 ▶ * ▶ ▶ mailbox no. ▶ ▶ VPS password # <ul style="list-style-type: none"> • If you have no password, you can skip the last step.
Leaving a message	 ▶ VPS extension no. ▶ # 6 ▶ ▶ mailbox no. / # 1 ▶ Enter the first 3 or 4 letters of the desired name ▶ ▶ Leave a message	
During playback	0 Repeat Voice Guidance * Exit Menu	

- KX-TVA series**
 - 1** Listen to Message
 - 2** Deliver Message
 - 3** Mailbox Management
 - ▶ **4** Automated Attendant
 - 5** Message Notification
 - 6** Other Features
 - *** End Call
- KX-TVS series**
 - 1** Listen to Message
 - 2** Deliver Message
 - 3** Check Mailbox Distribution
 - ▶ **4** Automated Attendant
 - 5** Mailbox Management
 - 6** Other Features
 - *** End Call

NOTE

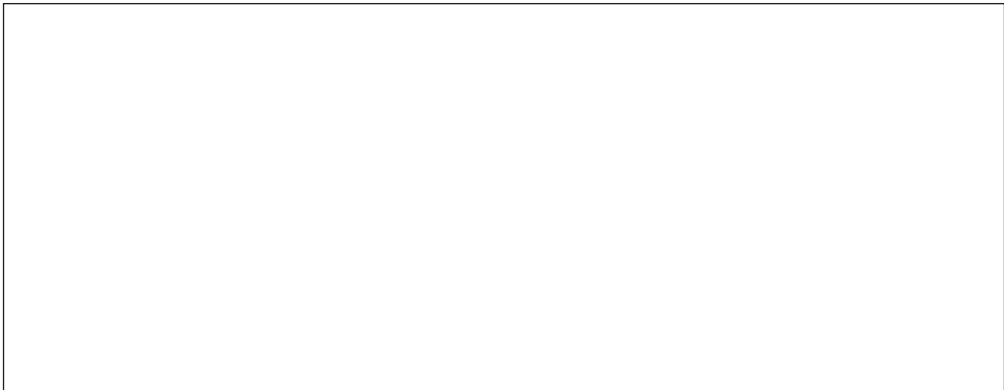

**Panasonic Consumer Electronics Company,
Division of Panasonic Corporation of North America**
One Panasonic Way, Secaucus, New Jersey 07094

Panasonic Puerto Rico, Inc.
San Gabriel Industrial Park, Ave. 65 de Infantería, Km. 9.5,
Carolina, Puerto Rico 00985

<http://www.panasonic.com/csd>

© 2005 Panasonic Communications Co., Ltd. All Rights Reserved.

PSQX3430XA KK0405ST2056